

## Product Details

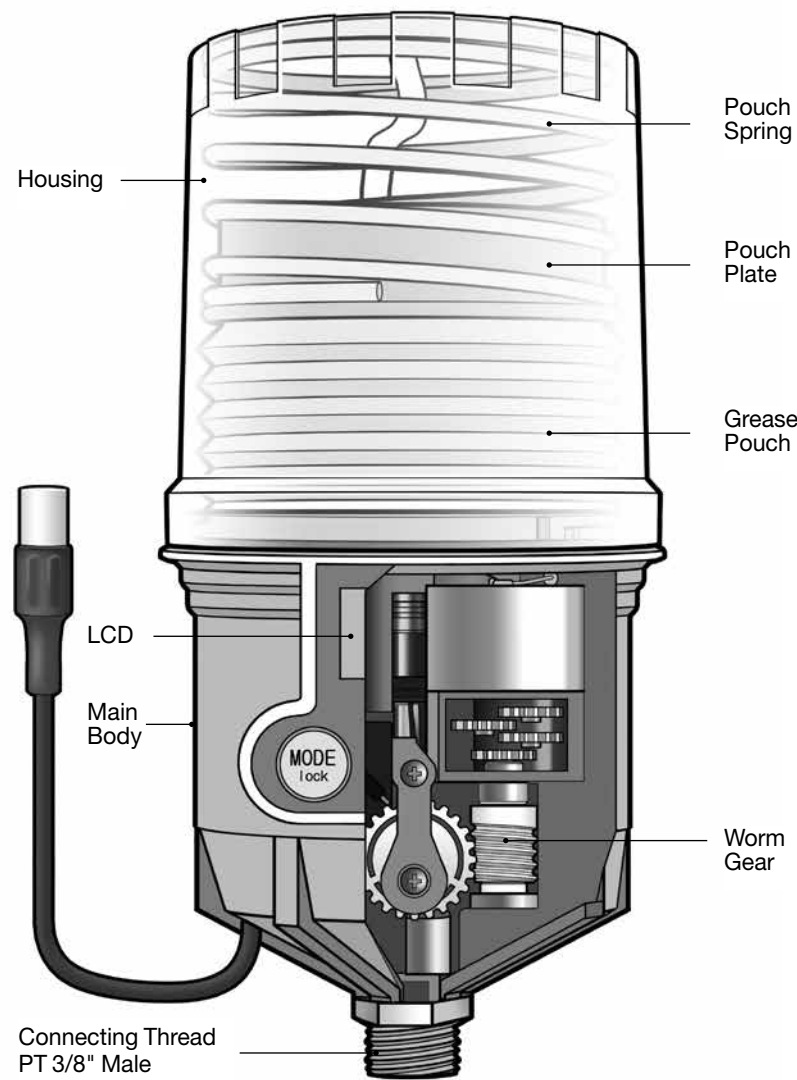

## Installation Guidelines

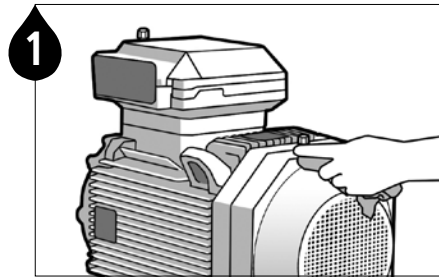

1 Remove contaminants around the lube point.

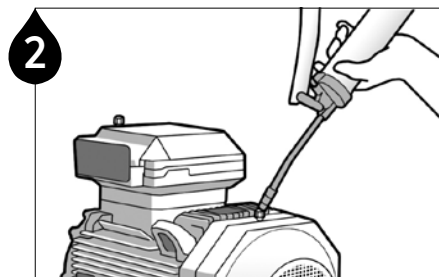

2 Ensure a clear passage using a manual grease gun. **Note1** Remove any hardened grease by purging the lube point with a manual grease gun. **Note2** The grease in the equipment and the grease contained in the unit should be the same or compatible.

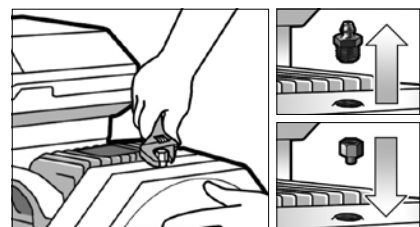

Remove the grease nipple and install appropriate adaptors.

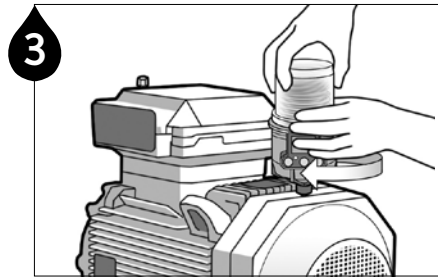

3 Install the lubricator on the lube point.

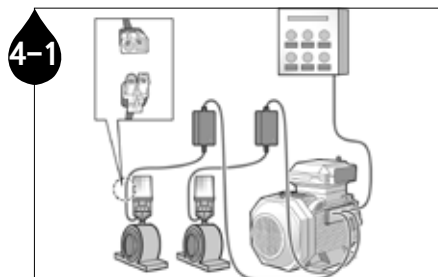

4-1 **MS** : Connect Relay Box to the control panel/equipment.

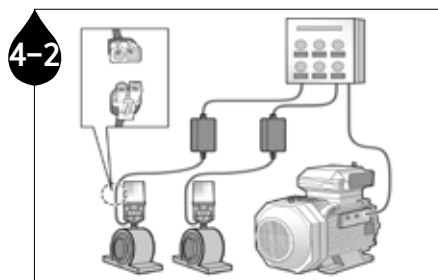

4-2 **MSP** : Connect VAC Adaptor (VDC Converter) to the control panel.

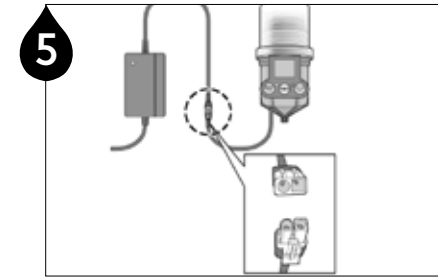

5 Connect unit's power cable to Relay Box/ VAC Adaptor (VDC Converter).

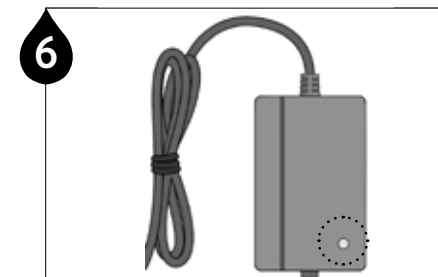

6 **MS & MSP** : Please make sure that red LED of VAC Adaptor (VDC Converter) or Relay box blinks once turning power on the equipment.

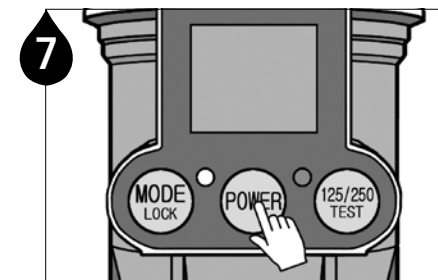

7 Press the POWER button for 2 seconds to turn the unit on.

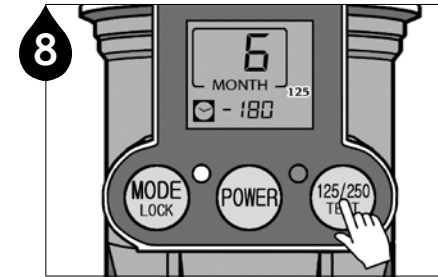

8 Select the appropriate grease pouch capacity by pressing the 125/250 TEST button.

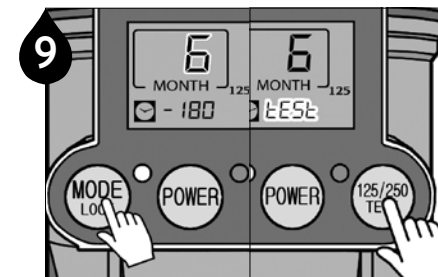

9 Press the MODE button to select dispensing period and hold the TEST button for 2 seconds to run a test cycle.

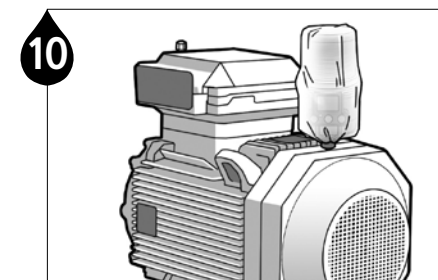

10 Install the dust cover over the lubricator for added protection.

## Troubleshooting Guidelines

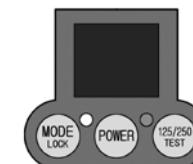

**Symptom** : Blank LCD screen  
**Possible Cause** : Electrical malfunction of CPU or circuitry, battery problem  
**Solution** : Replace battery pack or press reset button to restart the lubricator. If the problem persists, contact your supplier.

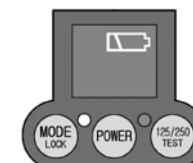

**Symptom** : Low Battery Indication  
**Possible Cause** : Rapid power consumption due to improper storage or harsh operating conditions (temperature, humidity, or high backpressure).  
**Solution** : Store the battery pack in cool, dry place and choose proper battery type for application. Optional lithium battery pack is available for more advanced applications.

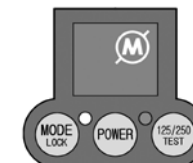

**Symptom** : Excessive Backpressure Indication  
**Possible Cause** : Excessive backpressure due to hardened grease, over-lubrication, ruptured lube line, long distance remote installation, etc.  
**Solution** : A) Check backpressure at lube point and/or lube line, B) check grease dispensing rate, C) reduce remote installation distance, or D) use manual grease gun to clear blockage.

## Wiring Options

**Note.** Power off before wiring.

**MS**  
Connecting Relay Box & Equipment & Control Panel

- Electric Motor or Power Cable
- Control Panel
- Other Terminal

**MSP VDC/VAC**

Select appropriate VAC Adaptor/VDC Converter needed for your application.

- Control Panel
- Other Terminal
- For DC powered units, please connect in corresponding polarity (+) to (+) and (-) to (-).

**Note**

Product warranty will be null and void if any faulty by incorrect wiring so please be aware of wiring method before installation. (Installation of electrical specialists is recommended)

## Safety Instructions

Please avoid to install in the following places for safety and reliability of Relay Box/VAC Adaptor (VDC Converter).

- High vibration areas
- Wet areas
- Where volatile and flammable substances are present and/or lube line, B) check grease dispensing rate, C) reduce remote installation distance, or D) use manual grease gun to clear blockage.
- Places with poor ventilation and high ambient temperatures

## Button Operation

### Dispensing Period

Press to set dispensing period

60ml: 1-12 month  
125/250ml: 1, 2, 3, 6, 12 month & 15 days (H)  
500ml: 1, 2, 4, 6, 12, 18, 24 month & 15 days (H)

### MODE LOCK

Automatic Lock Out Mode  
Press for 2 seconds to unlock (🔒)

### POWER

Power **ON/OFF**  
Press to Power unit On or Off

### Grease Capacity

60ml/500ml

### TEST

#### TEST Mode

ON : Press for 2 seconds  
OFF : Short press of button  
(will stop after completion of ongoing cycle)

### Grease Capacity

Press to select 125ml/250ml

### 125/250 TEST

#### TEST Mode

ON : Press for 2 seconds  
OFF : Short press of button  
(will stop after completion of ongoing cycle)

## LCD Display



Dispensing period setting

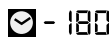

Remaining dispensing days



Automatic Lock Out mode

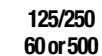

Grease pouch capacity

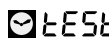

TEST mode



Number of days since the cycle ended (📅 and 📅 will also display)

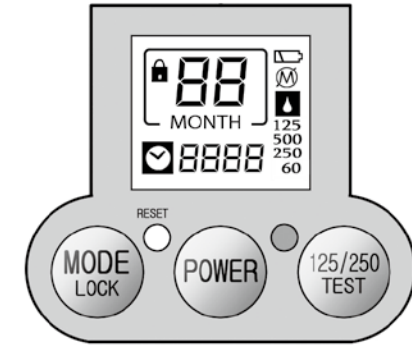

### RESET

Reset to default setting when the unit malfunctions and/or after changing the Service Pack

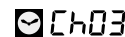

Number of days operation has been on hold due to excessive backpressure



Low battery power



Operation on hold due to excessive backpressure



Empty grease level



LED blinks when battery is low, excessive backpressure exists, or grease level is empty

ISO9001/14001 CE

## Mounting Methods

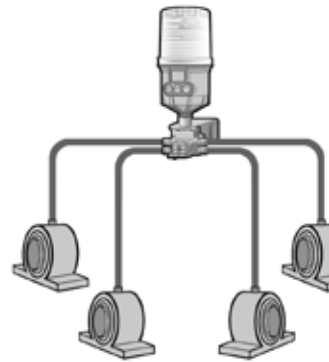
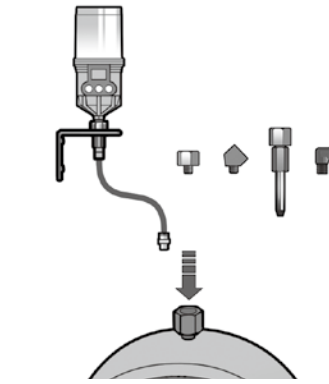

### Single Point Installation

#### Direct Mount or Remote Installation using Extension Tube

Direct mount is always preferable. For applications not allowing any direct mounts, remotely mount the unit using appropriate accessories and keep the distance from the lube point as short as possible.

For remote installation using a tube, use a Ø6 O.D. (1/4") tubing pre-filled with the same or compatible grease as the grease contained in the unit.

### Multi-Point Installation

#### Multi-Point Remote Installation using Progressive Divider Block (2~8 Points)

Remote multi-point lubrication is available with the Pulsarlube MS&MSP using a divider block. It is recommended to test the back pressure of the bearing, lube lines, and divider block after assembly using a grease gun connected to a pressure gauge. Ensure the break-off pressure is below the average operating pressure of 30bar (435psi).

### Warning

- ▶ For remote installation, keep the maximum distance at 6m (20ft) or less.
- ▶ Do not plug any open ports on the divider block. The kit or divider block must be ordered with the appropriate number of points required. For more information on the divider block, please refer to the Multi-Point Remote Installation Manual.
- ▶ Use the lithium battery pack for specific applications such as: extremely cold temperature, long period mode setting (18M, 24M), or multi-point remote installation for MS&MSP 500ml unit.

**Shelf life and Product Warranty** Warranty is limited to original defects in material and workmanship and will not cover any collateral damage due to mishandling, abuse and /or any other inappropriate use of this product. Warranty period is 1 year from the date of purchase.

Rev.02

# PULSARLUBE

The World Leader of Automatic Lubrication

### Pulsarlube USA, Inc.

1480 Howard Street, Elk Grove Village, IL 60007, USA

TEL:1-847-593-5300 FAX:1-847-593-5303 www.pulsarlube.com/info@pulsarlube.com

# PULSARLUBE

## User Manual

# Pulsarlube MS&MSP Series (60ml/125&250ml/500ml)

