

Product Details

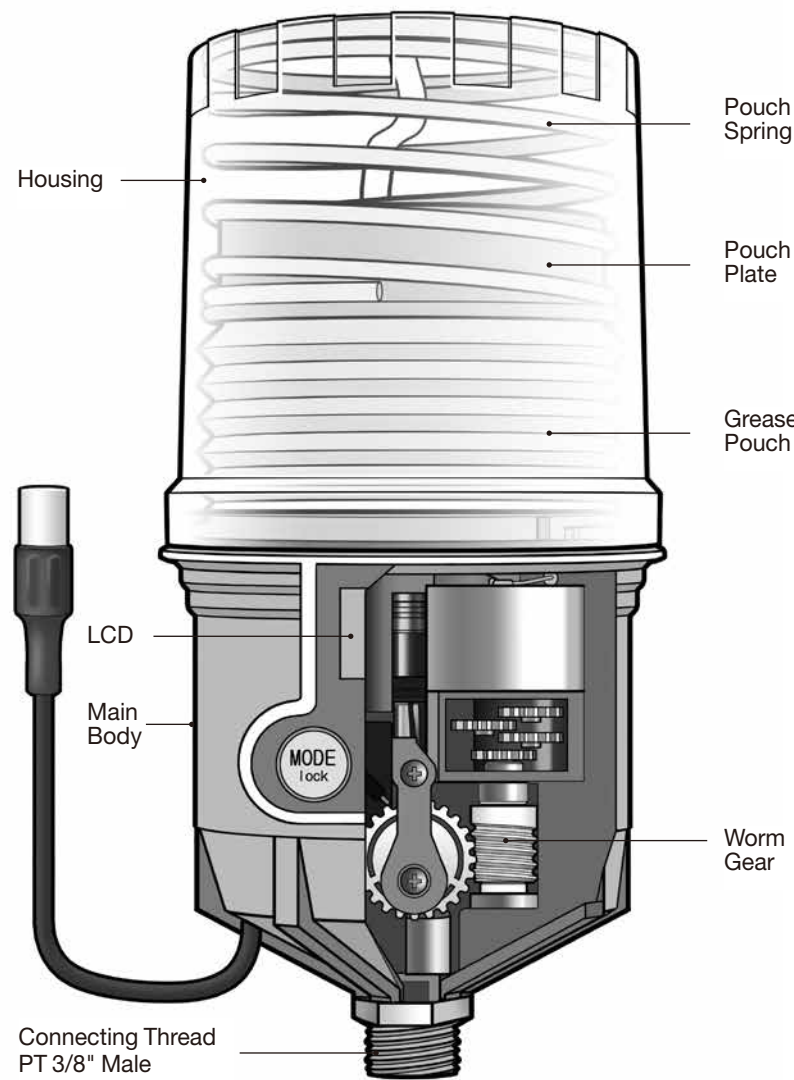

Installation

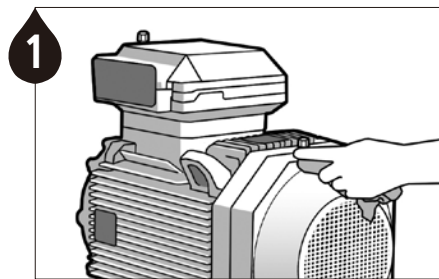

1 Remove contaminants around the lube point.

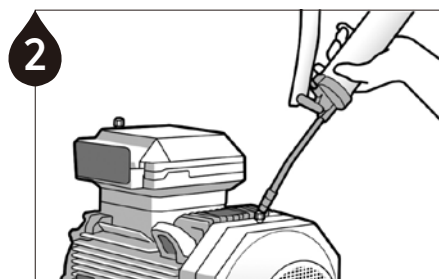

2 Ensure a clear passage using a manual grease gun. **Note1** Remove any hardened grease by purging the lube point with a manual grease gun. **Note2** The grease in the equipment and the grease contained in the unit should be the same or compatible.

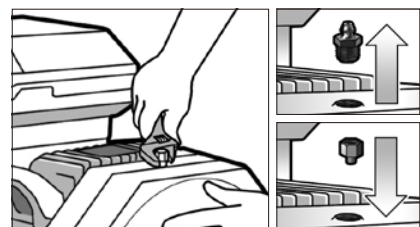

Remove the grease nipple and install appropriate adaptors.

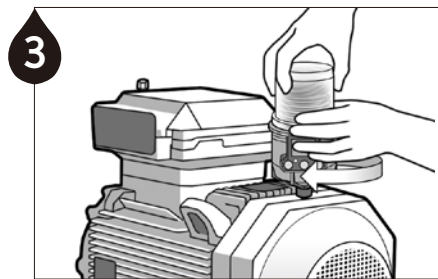

3 Install the lubricator on the lube point.

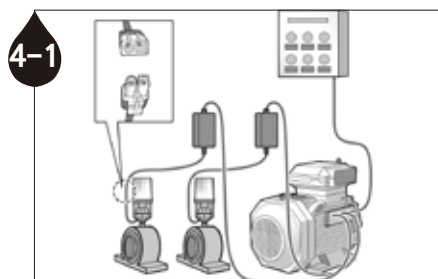

4-1 **MS** : Connect Relay Box to the control panel/equipment.

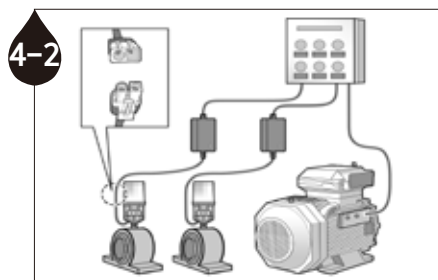

4-2 **MSP** : Connect VAC Adaptor (VDC Converter) to the control panel.

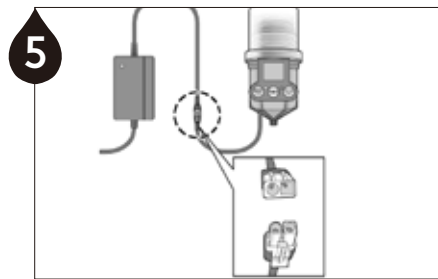

5 Connect unit's power cable to Relay Box/ VAC Adaptor (VDC Converter).



6 **MS & MSP** : Please make sure that red LED of VAC Adaptor (VDC Converter) or Relay box blinks once turning power on.

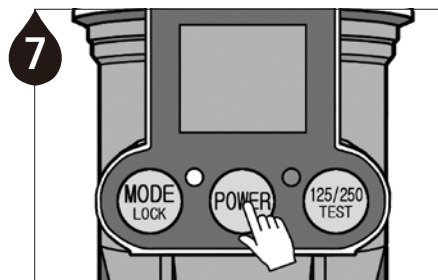

7 Press the POWER button for 2 seconds to turn the unit on.

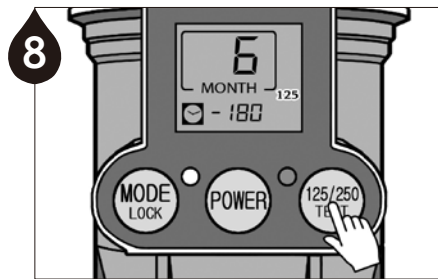

8 Select the appropriate grease pouch capacity by pressing the 125/250 TEST button.

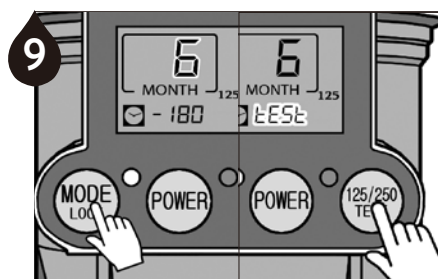

9 Press the mode button to select dispensing period and hold the test button for 2 seconds to run a test cycle.

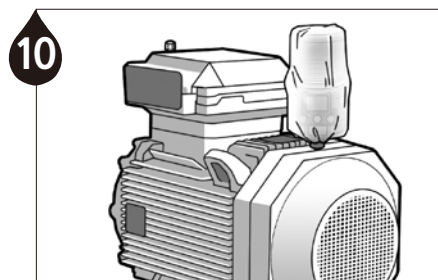

10 Install the dust cover over the lubricator for added protection.

Troubleshooting Guidelines

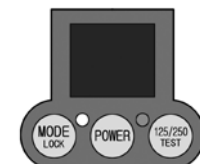

Symptom: Blank LCD screen
Possible Cause: Electrical malfunction of CPU or circuitry, battery problem
Solution: Replace battery pack or press reset button to restart the lubricator. If the problem persists, contact your supplier.

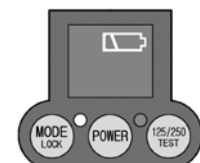

Symptom: Low Battery Indication
Possible Cause: Rapid power consumption due to improper storage or harsh operating conditions (temperature, humidity, or high backpressure).
Solution: Store the battery pack in cool, dry place and choose proper battery type for application. Optional lithium battery pack is available for more advanced applications.



Symptom: Excessive Backpressure Indication
Possible Cause: Excessive backpressure due to hardened grease, over-lubrication, ruptured lube line, long distance remote installation, etc.
Solution: A) Check backpressure at lube point and/or lube line, B) check grease dispensing rate, C) reduce remote installation distance, or D) use manual grease gun to clear blockage.

Wiring Options

Note. Power off before wiring.

MS
Connecting Relay Box & Equipment & Control Panel

- Electric Motor or Power Cable
- Control Panel
- Other Terminal

MSP VDC/VAC

Select appropriate VAC Adaptor/VDC Converter needed for your application.

- Control Panel
- Other Terminal
- For DC powered units, please connect in corresponding polarity (+) to (+) and (-) to (-).

Note

Product warranty will be null and void if any faulty by incorrect wiring so please be aware of wiring method before installation. (Installation of electrical specialists is recommended)

Safety Instructions

Please avoid to install in the following places for safety and reliability of Relay Box/VAC Adaptor (VDC Converter).

- High vibration areas
- Wet areas
- Where volatile and flammable substances are present and/or lube line, B) check grease dispensing rate, C) reduce remote installation distance, or D) use manual grease gun to clear blockage.
- Places with poor ventilation and high ambient temperatures

Functions

MODE LOCK
Dispensing Period
 Press To Set Dispensing Period

POWER
 Power **ON/OFF**
 Press to Power unit On or Off

TEST
For 60ml/500ml unit
 Press the button for 2 seconds to run a test cycle

125/250 TEST
For 125ml/250ml unit
A) Press the button to select 125ml or 250ml capacity **B)** Hold the button for 2 seconds to run a test cycle
**A quick press of the button will stop the test cycle mode*

LCD Displays

6
 MONTH
 Dispensing period setting

- 180
 Remaining dispensing days

Automatic Lock Out mode

125/250
 Grease pouch capacity
(default setting : 125ml)

60 or 500
 Grease capacity

TEST
 TEST mode

5603
 Number of days since the cycle ended (and will also display)

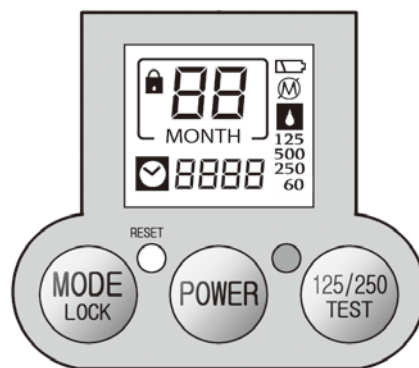

RESET
 Reset to default setting when the unit malfunctions and/or after changing the Service Pack

Ch03
 Number of days operation has been on hold due to excessive backpressure

Low battery power

Operation on hold due to excessive backpressure

Empty grease level

Red LED
 LED blinks when battery is low, excessive backpressure exists, or grease level is empty

ISO9001/14001 CE

Mounting Methods

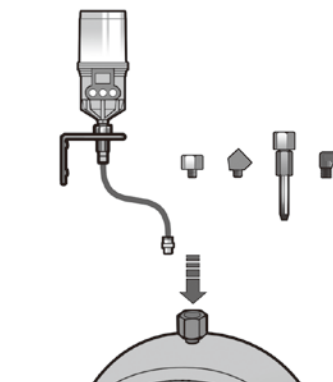

Single Point Installation

Direct Mount or Remote Installation using Extension Tube

Direct mount is always preferable.

For applications not allowing any direct mounts, remotely mount the unit using appropriate accessories and keep the distance from the lube point as short as possible.

For remote installation using a tube, use a 6mm O.D. (1/4") tubing pre-filled with the same or compatible grease as the grease contained in the unit.

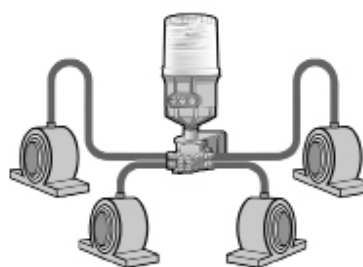

Multi-Point Installation

Multi-Point Remote Installation using Progressive Divider Block (2~8 Points)

Remote multi-point lubrication is available with the Pulsarlube M using a divider block.

It is recommended to test the back pressure of the bearing, lube lines, and divider block after assembly using a grease gun connected to a pressure gauge. Ensure the break-off pressure is below the average operating pressure of 30bar (435psi).

Warning

- ▶ For remote installation, keep the maximum distance at 6m (20ft) or less.
- ▶ Do not plug any open ports on the divider block. The kit or divider block must be ordered with the appropriate number of points required. For more information on the divider block, please refer to the Multi-Point Remote Installation Manual.
- ▶ Use the lithium battery pack for specific applications such as: extremely cold temperature, long period mode setting (18M, 24M), or multi-point remote installation for M 500ml unit.

Shelf life and Warranty Product Warranty is limited to original defects in material and workmanship and will not cover any collateral damage due to mishandling, abuse and /or any other inappropriate use of this product. Warranty period is 1 year from the date of purchase.

Rev.00

PULSARLUBE

The World Leader of Automatic Lubrication

Pulsarlube USA, Inc.

1480 Howard Street, Elk Grove Village, IL 60007, USA
 TEL:1-847-593-5300 FAX:1-847-593-5303 www.pulsarlube.com / info@pulsarlube.com

PULSARLUBE

User Manual

Pulsarlube MS&MSP Series

(60ml/125 & 250ml/500ml)

